

A complex technical wireframe drawing of a gear assembly, rendered in white lines on a black background. The drawing shows multiple gears of different sizes and profiles, including a large gear on the left and several smaller gears on the right. The lines are thin and precise, highlighting the intricate geometry of the teeth and shafts. The overall composition is dense and technical, typical of engineering drawings.

Koken Z-series

Koken TOOL CO., LTD.

Koken Z-series



Z-series MOVIE

Z series - Evolution of Automotive service Lineup

■ - CONCEPT -

Continued advancements in engine designs and structures are producing engines that are more complex and compact.

Work environments are being transformed to cater towards increased demands on auto mechanics. We at Ko-ken TOOL CO., LTD., specialists in socket wrench manufacturing, have been committed to the development of automotive tools that are more suitable by pouring in our passion for perfecting hand tools and utilizing our experience obtained through over half a century of manufacturing to create the Z series.

"Z" stands for "zeal". Through their unequalled performance, Z-Series tools are certain to become the mechanic's new standard for the next generation of automotive tools.

■ - OVERALL -



• Designed for best performance

The designs were thoroughly reviewed to produce the Z-series.

All items in this series are now more compact.

Foregoing standards, radical design concepts have been implemented in producing the Z series which enables maximum potential in all professional mechanics.

• Tolerance – Square drive

Movement at the joint between a socket and a ratchet or other drive accessory has been accepted as unavoidable.

To reduce this movement, we thoroughly reviewed dimensional accuracy of all the joint parts of Z-Series, and any movement in the rotating direction has now been minimized through production technologies.

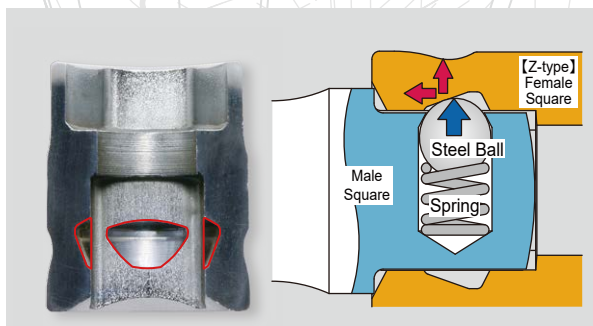
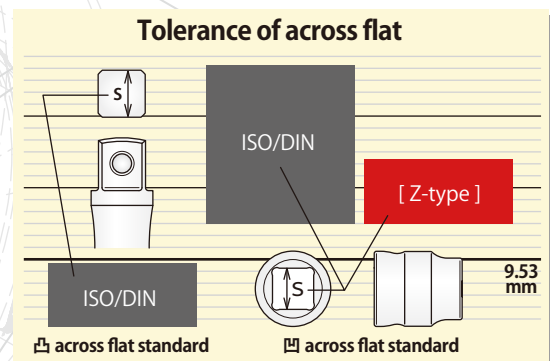

• Ball Holding Groove

The new Ball Holding system was installed. Any movement in the connecting direction has been reduced by a mechanism that pulls the parts together.

REVERSIBLE RATCHET



72 tooth gear Ratchet Handle - Light Ratchet Movement

This ratchet handle has a new mechanism for enhanced usability.

This Ratchet has incredibly light turning torque that enables working on loosely tightened bolts.

With the compact head and balanced design, the Z-Series ratchet has evolved into what can be called the "ideal ratchet handle".

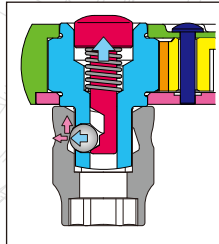
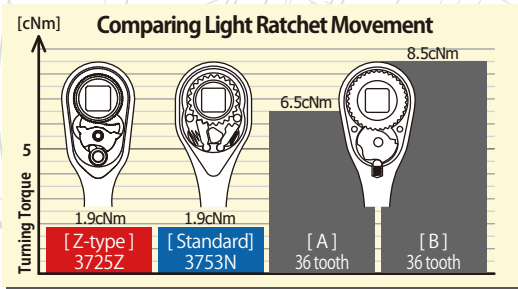

Push release : Locking type

Innovative new locking mechanism is installed. This new mechanism achieved both of locking a socket and also unique feature of Z-series pulls parts together for tight connection.

A, B : Other brand

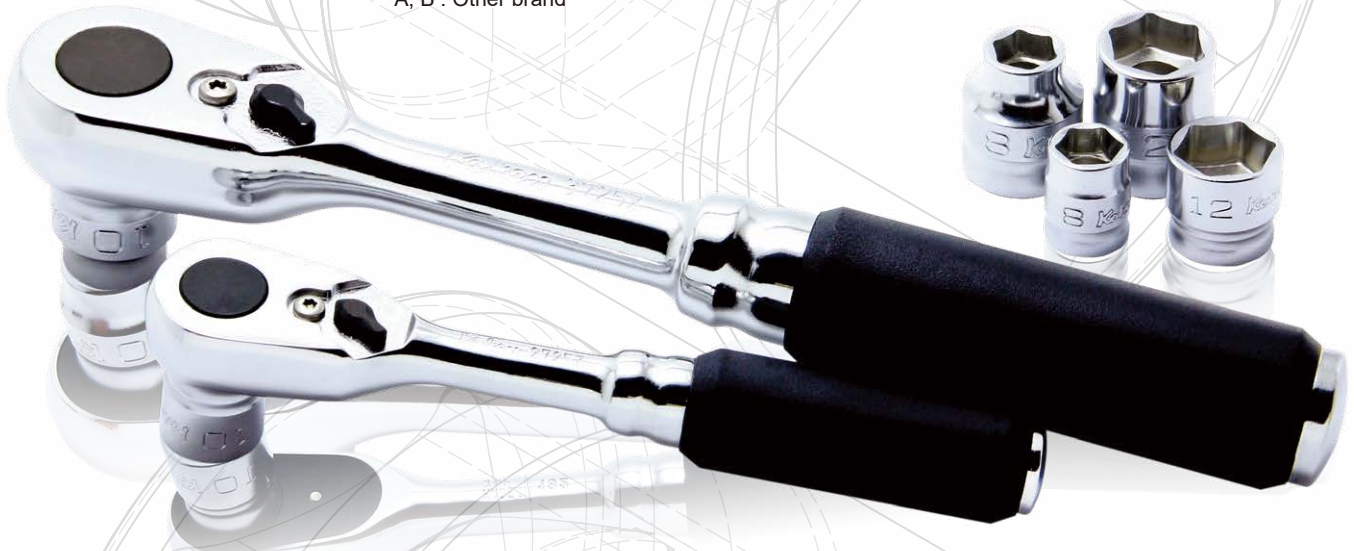

SOCKETS

Compact

The length and diameter of sockets have been significantly reduced.

Ideal for working in confined and tight areas.

Comparison of 10mm Sockets-

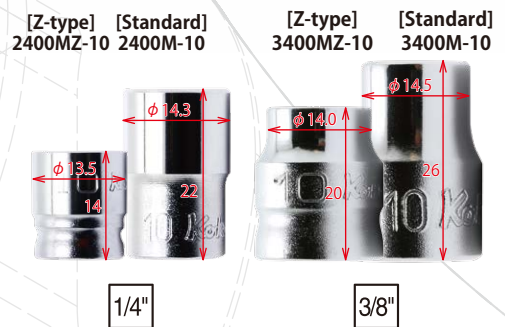

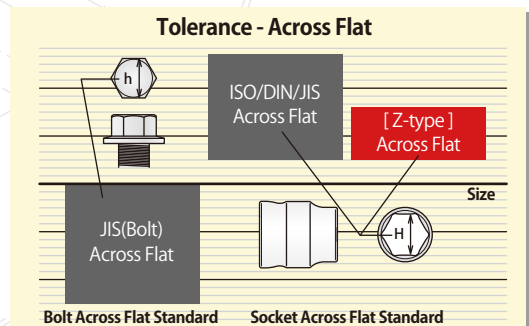

Tolerance - Hexagon Opening.

Foregoing the ISO and DIN standards, radical design concepts have been implemented in producing the Z series which enables maximum potential in all professional mechanics.

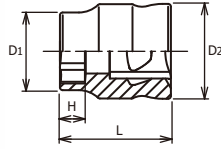

 6-point Sockets
Vasos Hexagonales **2400MZ**



2400MZ (mm)	D1 (mm)	D2 (mm)	H (mm)	L (mm)	 (g)	 (pcs.)
4	6.4	11	3	14	6	10
4.5	7	11	3	14	6	10
5	7.6	11	3	14	6	10
5.5	8.2	11	3.5	14	6	10
6	8.8	11	3.5	14	6	10
7	9.9	11	3.5	14	6	10
8	11.1	11.7	4.5	15	7	10
10	13.5	12.5	7	15	8	10
11	14.7	13.2	7	15	9	10
12	15.9	14.4	7	15	11	10
13	17.1	15.6	7	15	14	10
14	18.3	16.8	7	15	16	10



  Socket Set on Rail
Juego de Vasos en Regleta **RS2400MZ/12**

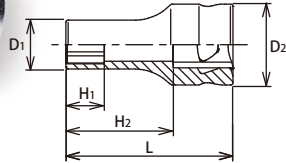

RS2400MZ/12	12 Pieces Set / Rail 200mm	 (g)
4, 4.5, 5, 5.5, 6, 7, 8, 10, 11, 12, 13, 14		228

 6-point Sockets, Semi-Deep
Vasos Hexagonales, Medianos **2300XZ**



2300XZ (mm)	D1 (mm)	D2 (mm)	H1 (mm)	H2 (mm)	L (mm)	 (g)	 (pcs.)
5.5	8.2	11	6	20	30	10	10
6	8.8	11	7	20	30	10	10
7	9.9	11	8	20	30	11	10
8	11.1	11.7	9	20	30	13	10
10	13.5	12.5	11	20	30	16	10
11	14.7	13.2	12	20	30	19	10
12	15.9	14.4	13	20	30	22	10
13	17.1	15.6	14	20	30	26	10
14	18.3	16.8	14	20	30	30	10



  Socket Set on Rail
Juego de Vasos en Regleta **RS2300XZ/9**

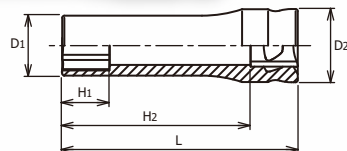

RS2300XZ/9	9 Pieces Set / Rail 200mm	 (g)
5.5, 6, 7, 8, 10, 11, 12, 13, 14		290

 6-point Deep Sockets
Vasos Hexagonales Largos **2300MZ**



2300MZ (mm)	D1 (mm)	D2 (mm)	H1 (mm)	H2 (mm)	L (mm)	 (g)	 (pcs.)
4	6.4	11	5	41	50	14	10
4.5	7	11	5.5	41	50	16	10
5	7.6	11	6	41	50	16	10
5.5	8.2	11	6.5	41	50	16	10
6	8.8	11	7	41	50	17	10
7	9.9	11	8	41	50	20	10
8	11.1	11.7	9	41	50	22	10
10	13.5	12.5	11	41	50	29	10
11	14.7	13.2	12	41	50	33	10
12	15.9	14.4	13	41	50	40	10
13	17.1	15.6	14	41	50	45	10
14	18.3	16.8	16	41	50	51	10

  Socket Set on Rail
Juego de Vasos en Regleta **RS2300MZ/12**



RS2300MZ/12	12 Pieces Set / Rail 200mm	 (g)
4, 4.5, 5, 5.5, 6, 7, 8, 10, 11, 12, 13, 14		445

2441MZ



Nut Grip Universal Sockets **Nut Grip®**
Vasos Sujeta-Tuercas con Articulación Universal

	2441MZ (mm)	D ₁ (mm)	D ₂ (mm)	H (mm)	L (mm)	(g)	(pcs.)
New	8	12.3	11.7	4.5	30.5	18	10
New	10	14.3	11.7	4.5	30.5	20	10
New	12	16.8	11.7	5.5	31.5	25	10
New	13	18	11.7	5.5	31.5	27	10
New	14	20	11.7	7	33	31	10

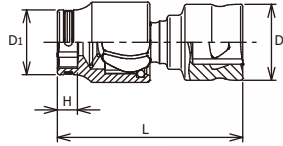

2000Z-28·-50



PH Bit Sockets
Vasos con Punta PH

	2000Z.28 (PH)	D (mm)	H (mm)	L (mm)	(g)	(pcs.)
	1	11.2	12	28	9	10
	2	11.2	12	28	10	10
	3	11.2	12	28	10	10

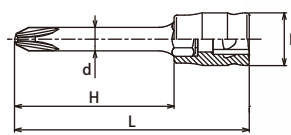

	2000Z.50 (PH)	D (mm)	d (mm)	H (mm)	L (mm)	(g)	(pcs.)
	1	11.2	4	34	50	11	10
	2	11.2	5	34	50	13	10
	3	11.2	-	34	50	16	10



*Größe PH3 : 1/4" 6-kant Schaft

2005Z-25



Slotted Bit Sockets
Vasos con Punta Recta para Cabeza Ranurada

	2005Z.25	T x W (mm)	D (mm)	H (mm)	L (mm)	(g)	(pcs.)
	5	1.0 x 5.5	11.2	9	25	9	10
	6	1.2 x 6.5	11.2	9	25	10	10

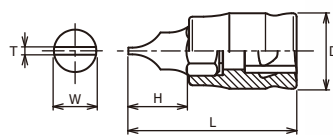

2010MZ-25·-50



Inhex Bit Sockets
Vasos con Punta Hexagonal

	2010MZ.25 (mm)	D (mm)	H (mm)	L (mm)	(g)	(pcs.)
	3	11.2	9	25	9	10
	4	11.2	9	25	9	10
	5	11.2	9	25	10	10
	6	11.2	9	25	10	10

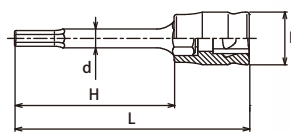

	2010MZ.50 (mm)	D (mm)	d (mm)	H (mm)	L (mm)	(g)	(pcs.)
	3	11.2	4	34	50	11	10
	4	11.2	5	34	50	13	10
	5	11.2	6	34	50	15	10
	6	11.2	-	34	50	17	10



*Size 6 : 1/4" Hex Shank

RS20XXZ/9



Socket Set on Rail
Juego de Vasos en Regleta

RS20XXZ/9		12 Pieces Set / Rail 200mm	(g)
2000Z.28		1, 2, 3	213
2005Z.25		5, 6	
2010MZ.25		3, 4, 5, 6	



TORX® Bit Sockets
Vasos con Punta TORX® **2025Z-28**

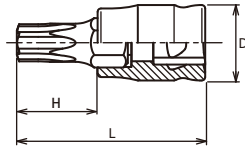

2025Z.28 (T)	D (mm)	H (mm)	L (mm)	(g)	(pcs.)
T10	11.2	12	28	9	10
T15	11.2	12	28	9	10
T20	11.2	12	28	9	10
T25	11.2	12	28	10	10
T27	11.2	12	28	10	10
T30	11.2	12	28	10	10
T40	11.2	12	28	11	10

TORX® Bit Sockets
Vasos con Punta TORX® **2025Z-50**

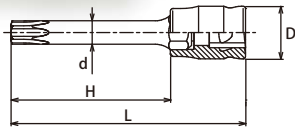

2025Z.50 (T)	D (mm)	d (mm)	H (mm)	L (mm)	(g)	(pcs.)
T10	11.2	4	34	50	11	10
T15	11.2	4	34	50	11	10
T20	11.2	4.5	34	50	12	10
T25	11.2	5	34	50	13	10
T27	11.2	5	34	50	13	10
T30	11.2	5.6	34	50	15	10
T40	11.2	-	34	50	17	10

*Size T40 : 1/4" Hex Shank

Socket Set on Rail
Juego de Vasos en Regleta **RS2025Z/7-L28**
RS2025Z/7-L50



RS2025Z/7-L28	7 Pieces Set / Rail 200mm	(g)
T10, T15, T20, T25, T27, T30, T40		195
RS2025Z/7-L50	7 Pieces Set / Rail 200mm	(g)
T10, T15, T20, T25, T27, T30, T40		220

Reversible Ratchet
Llave de Carraca Reversible **2725Z**

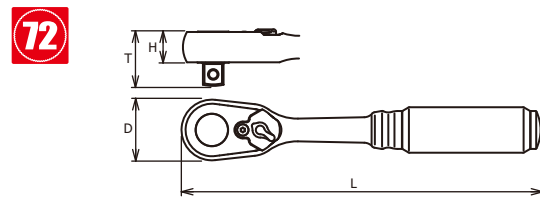

	D (mm)	T (mm)	H (mm)	L (mm)	(g)	(pce.)
2725Z	20.5	17.1	9.5	114	79	1

Reversible Ratchet Long
Llave de Carraca Reversible Larga **2725Z-160** ⚠

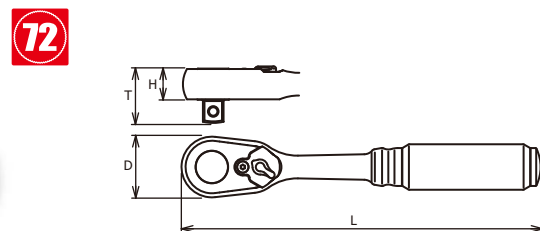

	D (mm)	T (mm)	H (mm)	L (mm)	(g)	(pce.)
2725Z-160	20.5	17.1	9.5	160	115	1

⚠ 2725Z-160 have longer handle than standard, and can be loaded to excessive torque value. In the interest of your own safety always apply load evenly and progressively to avoid breakage and possible injury.

🔧 : Ratchet handles have been modified from 36 tooth to 72 tooth.

TORX® ist ein registriertes Markenzeichen der Firma **CAMCAR Innovations**.
TORX® es una marca registrada de **CAMCAR Innovations**.

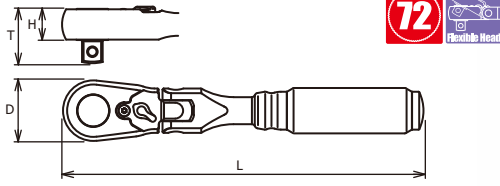

2726Z Flexible Ratchet, Reversible
Llave de Carraca Flexible, Reversible



	D (mm)	T (mm)	H (mm)	L (mm)	(g)	(pce.)
2726Z	20.5	17.1	9.5	114	103	1

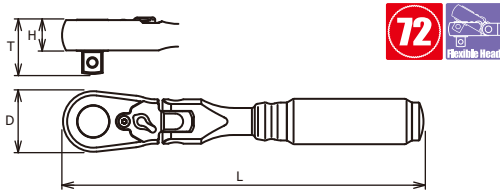

2726Z-160 ⚠ Flexible Ratchet, Reversible
Llave de Carraca Flexible, Reversible



	D (mm)	T (mm)	H (mm)	L (mm)	(g)	(pce.)
2726Z-160	20.5	17.1	9.5	160	125	1

⚠ 2726Z-160 have longer handle than standard, and can be loaded to excessive torque value. In the interest of your own safety always apply load evenly and progressively to avoid breakage and possible injury.



🔧 : Ratchet handles have been modified from 36 tooth to 72 tooth.

Extension Bars
Alargaderas

2760Z

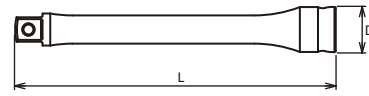

2760Z	D (mm)	L (mm)	(g)	(pcs.)
50	11.5	50	21	10
100	11.5	100	39	10
150	11.5	150	58	10

Universal Joint
Articulación Universal

2771Z

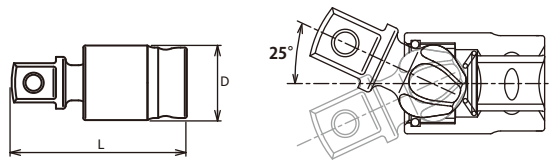

Universal Joint

2771Z	D (mm)	L (mm)	(g)	(pcs.)
2771Z	11.7	29.9	15	10

Universal Joint
Articulación Universal

2772Z

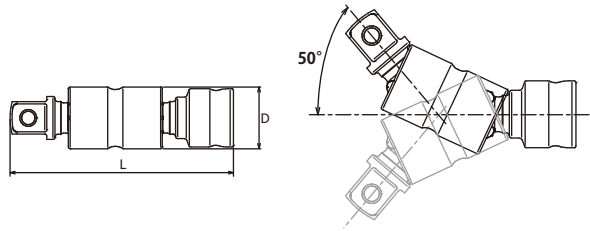

2772Z	D (mm)	L (mm)	(g)	(pcs.)
2772Z	11.7	46	26	10

Quick Spinner
Disco de Giro Rápido

2756Z

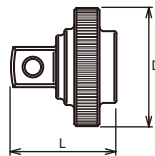

2756Z	D (mm)	L (mm)	(g)	(pcs.)
2756Z	20.3	18	15	10

Quick Spinner
Disco de Giro Rápido

2756Z-3/8
2756Z-1/2

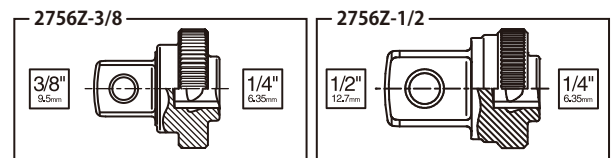
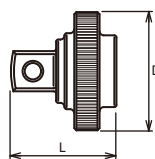

	D (mm)	L (mm)	(g)	(pcs.)
2756Z-3/8	20.3	21.5	24	10
2756Z-1/2	20.3	26	35	10

P2285Z		26 Pieces Set / 660 g	
PLASTIC CASE : W245xH120xT45mm			
Sockets		Accessories	
	2400MZ 6-pt. Sockets 4, 4.5, 5, 5.5, 6, 7, 8, 10, 11, 12, 13, 14		2725 Z
	2000Z.28 1, 2, 3		2756 Z
	2005Z.25 5, 6		2771Z
	2010MZ.25 3, 4, 5, 6		2760Z-50
			2760Z-150

P2285Z Socket Set
Juego de Vasos



2286Z		17 Pieces Set / 780 g	
BLACK METAL CASE : W240xH100xT32mm			
Sockets		Accessories	
	2400MZ 6-pt. Sockets 4, 5, 5.5, 6, 7, 8, 10, 11, 12, 13, 14		2725 Z
			2756 Z
			2771Z
			2760Z-50
			2760Z-100
			2760Z-150

2286Z Socket Set
Juego de Vasos



2285ZE		10 Pieces Set / 300g	
Rail 200mm / PLASTIC BAG			
Sockets		Accessories	
	2400MZ 6-pt.Sockets 5.5, 6, 7, 8, 10, 12, 13, 14		2725 Z
			2756 Z



2285ZE Socket Set
Juego de Vasos



 6-point Sockets
Vasos Hexagonales

3400MZ



3400MZ (mm)	D1 (mm)	D2 (mm)	H (mm)	L (mm)	 (g)	 (pcs.)
5.5	8.5	17	3.5	19	16	10
6	9.1	17	3.5	19	17	10
7	10.3	17	3.5	19	17	10
8	11.5	17	4.5	20	17	10
10	14	17	4.5	20	18	10
11	15.3	17	5.5	21	18	10
12	16.5	17	5.5	21	19	10
13	17.8	17	8.5	21	19	10
14	19	17	8.5	21	20	10
15	20.2	18.2	8.5	21	24	10
16	21.3	19.3	8.5	21	28	10
17	22.5	20.5	8.5	21	32	10
18	23.6	21.6	9.5	22	38	10
19	24.8	22.8	9.5	22	41	10
21	27	25	10.5	23	51	10
22	28.3	26.3	10.5	23	58	10

  Socket Set on Rail
Juego de Vasos en Regleta

RS3400MZ/8 RS3400MZ/12





RS3400MZ/8	8 Pieces Set / Rail 200mm	 (g)
8, 10, 11, 12, 13, 14, 17, 19		320

RS3400MZ/12	12 Pieces Set / Rail 300mm	 (g)
7, 8, 10, 11, 12, 13, 14, 15, 16, 17, 18, 19		490

 6-point Sockets, Semi-Deep
Vasos Hexagonales, Medianos

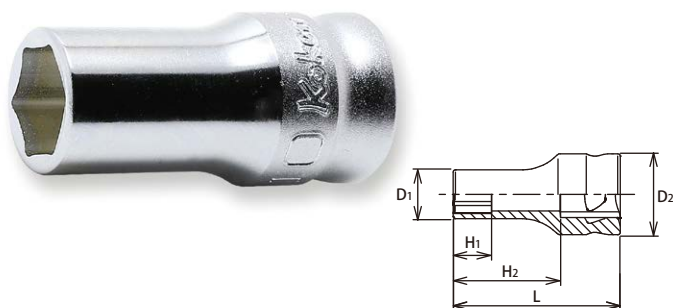
3300XZ



3300XZ (mm)	D1 (mm)	D2 (mm)	H1 (mm)	H2 (mm)	L (mm)	 (g)	 (pcs.)
7	10.3	17	8	23	35	23	10
8	11.5	17	9	23	35	24	10
10	14	17	11	23	35	26	10
11	15.3	17	12	23	35	28	10
12	16.5	17	13	23	35	29	10
13	17.8	17	14	23	35	32	10
14	19	17	16	23	35	34	10
15	20.2	18.2	16	23	35	40	10
16	21.3	19.3	16.5	23	35	45	10
17	22.5	20.5	16.5	23	35	50	10
18	23.6	21.6	16.5	23	35	56	10
19	24.8	22.8	18	23	35	60	10

  Socket Set on Rail
Juego de Vasos en Regleta

RS3300XZ/8 RS3300XZ/12



RS3300XZ/8	8 Pieces Set / Rail 200mm	 (g)
8, 10, 11, 12, 13, 14, 17, 19		420

RS3300XZ/12	12 Pieces Set / Rail 300mm	 (g)
7, 8, 10, 11, 12, 13, 14, 15, 16, 17, 18, 19		630



3300MZ (mm)	D ₁ (mm)	D ₂ (mm)	H ₁ (mm)	H ₂ (mm)	L (mm)	(g)	(pcs.)
7	10.3	17	8	41.5	55	29	10
8	11.5	17	9	41.5	55	34	10
10	14	17	11	41.5	55	43	10
11	15.3	17	12	41.5	55	45	10
12	16.5	17	13	41.5	55	49	10
13	17.8	17	14	41.5	55	52	10
14	19	17	16	41.5	55	55	10
15	20.2	18.2	16	40.5	55	65	10
16	21.3	19.3	17	40.5	55	74	10
17	22.5	20.5	18	40.5	55	83	10
18	23.6	21.6	19	39.5	55	90	10
19	24.8	22.8	20	39.5	55	95	10

3300MZ



6-point Deep Sockets
Vasos Hexagonales Largos

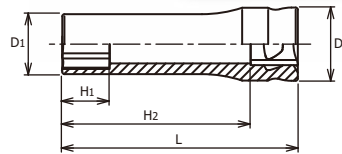

RS3300MZ/8 RS3300MZ/12



Socket Set on Rail
Juego de Vasos en Regleta

RS3300MZ/8	8 Pieces Set / Rail 200mm	(g)
8, 10, 11, 12, 13, 14, 17, 19		600
RS3300MZ/12	12 Pieces Set / Rail 300mm	(g)
7, 8, 10, 11, 12, 13, 14, 15, 16, 17, 18, 19		900



RS3X00MZ/12



Socket Set on Rail
Juego de Vasos en Regleta

RS3X00MZ/12	12 Pieces Set / Rail 300mm	(g)
3400MZ	8, 10, 11, 12, 13, 14, 17, 19	550
3300MZ	8, 10, 12, 14	



Spark Plug Socket

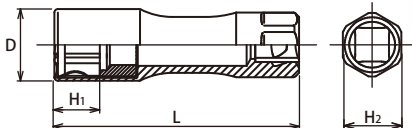

3300CZ (mm)	D (mm)	H ₁ (mm)	H ₂ (mm)	L (mm)	(g)	(pcs.)
14	18.4	11	17	70	67	10
16	20.5	13	17	70	71	10
18	22.9	12	17	70	75	10
20.8	26.3	13.5	17	70	105	10

Slim & light weight body with smaller outside diameter for work in tight spaces.

⚠ Spring clip type spark plug sockets caused deforming the clip if it would be used with shallow engagement.



Spark Plug, 12-pt. Size:14mm

3305PZ (mm)	D (mm)	H ₁ (mm)	H ₂ (mm)	L (mm)	(g)	(pcs.)
14	17.9	8	17	70	56	10
16	20	8	17	70	55	10

⚠ The magnet could be broken with any impacts. Please handle with care.

3300CZ



Spark Plug Sockets with Spring Clips
Llaves de Bujía con Presillas



3305PZ



Spark Plug Sockets with Magnet, 12-pt. opening
Llaves de Bujía con Imán, Boca Bihex

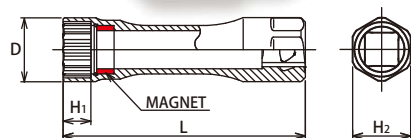

Nut Grip Universal Sockets Nut Grip®
Vasos Sujeta-Tuercas con Articulación Universal **3441MZ**

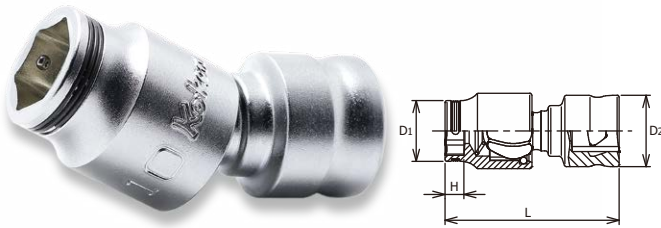

3441MZ (mm)	D1 (mm)	D2 (mm)	H (mm)	L (mm)	(g)	(pcs.)
New 8	12	17	4.5	41.5	45	10
New 10	14.5	17	4.5	41.5	47	10
New 12	16.8	17	5.5	42.5	50	10
New 13	17.8	17	5.5	42.5	53	10
New 14	19.5	17	7	44	55	10
New 17	23.4	17	8.5	45.5	66	10

Inhex Bit Sockets
Vasos con Punta Hexagonal **3010MZ-50-75**

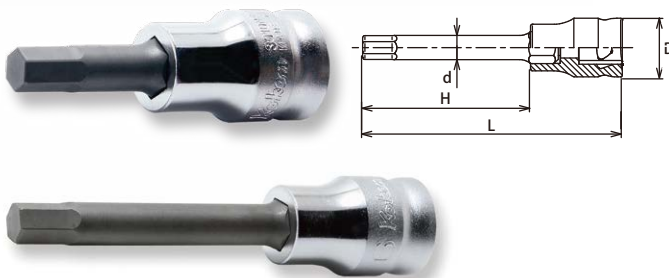

3010MZ.50 (mm)	D (mm)	H (mm)	L (mm)	(g)	(pcs.)
3	17	23.5	50	28	10
4	17	23.5	50	29	10
5	17	23.5	50	30	10
6	17	23.5	50	35	10
7	17	23.5	50	38	10
8	17	23.5	50	40	10
10	17	23.5	50	50	10
12	19	23.5	50	70	10

3010MZ.75 (mm)	D (mm)	d (mm)	H (mm)	L (mm)	(g)	(pcs.)
3	17	6	48.5	75	33	10
4	17	6	48.5	75	35	10
5	17	6	48.5	75	36	10
6	17	7	48.5	75	41	10
7	17	7.9	48.5	75	45	10
8	17	-	48.5	75	48	10
10	17	-	48.5	75	65	10
12	19	-	48.5	75	90	10

*Size 8,10,12 : Hex Shank

Socket Set on Rail
Juego de Vasos en Regleta **RS3010MZ/8-L50-L75**



RS3010MZ/8-L50	8 Pieces Set / Rail 200mm	(g)
3, 4, 5, 6, 7, 8, 10, 12		460

RS3010MZ/8-L75	8 Pieces Set / Rail 200mm	(g)
3, 4, 5, 6, 7, 8, 10, 12		530

TORX® Bit Sockets
Vasos con Punta TORX® **3025Z-50-75**

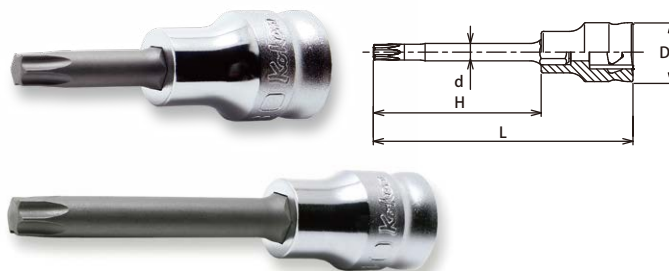

3025Z.50 (T)	D (mm)	H (mm)	L (mm)	(g)	(pcs.)
T10	17	23.5	50	27	10
T15	17	23.5	50	28	10
T20	17	23.5	50	28	10
T25	17	23.5	50	29	10
T27	17	23.5	50	30	10
T30	17	23.5	50	31	10
T40	17	23.5	50	35	10
T45	17	23.5	50	38	10
T50	17	23.5	50	48	10
T55	19	23.5	50	70	10

3025Z.75 (T)	D (mm)	d (mm)	H (mm)	L (mm)	(g)	(pcs.)
T20	17	4.5	48.5	75	32	10
T25	17	5	48.5	75	33	10
T27	17	5	48.5	75	33	10
T30	17	5.6	48.5	75	35	10
T40	17	6.7	48.5	75	41	10
T45	17	7.9	48.5	75	45	10
T50	17	8.9	48.5	75	55	10
T55	19	11.3	48.5	75	80	10

Socket Set on Rail
Juego de Vasos en Regleta **RS3025Z/8-L50-L75**



RS3025Z/8-L50	8 Pieces Set / Rail 200mm	(g)
T20, T25, T27, T30, T40, T45, T50, T55		450

RS3025Z/8-L75	8 Pieces Set / Rail 200mm	(g)
T20, T25, T27, T30, T40, T45, T50, T55		480

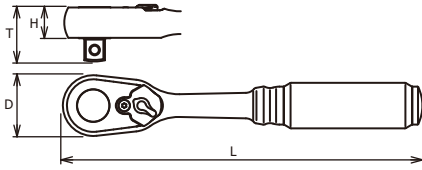

72

2725Z-3/8

Reversible Ratchet Short
Llave de Carraca Reversible Corta



	D (mm)	T (mm)	H (mm)	L (mm)	(g)	(pce.)
2725Z-3/8	20.5	20.5	9.5	114	83	1

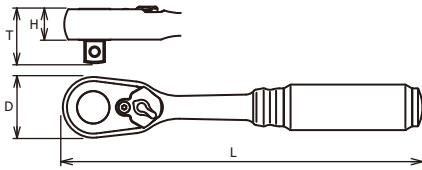

72

2725Z-3/8(L160) ⚠

Reversible Ratchet
Llave de Carraca Reversible



	D (mm)	T (mm)	H (mm)	L (mm)	(g)	(pce.)
2725Z-3/8(L160)	20.5	20.5	9.5	160	120	1

⚠ 2725Z-3/8(L160) have longer handle than standard, and can be loaded to excessive torque value. In the interest of your own safety always apply load evenly and progressively to avoid breakage and possible injury.

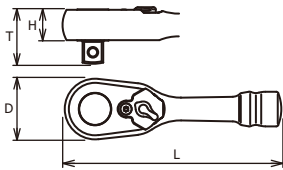

72

3725ZS

Reversible Ratchet Short
Llave de Carraca Reversible Corta



	D (mm)	T (mm)	H (mm)	L (mm)	(g)	(pce.)
3725ZS	28	24.5	13.7	100	157	1

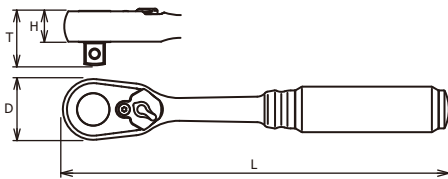

72

3725Z

Reversible Ratchet
Llave de Carraca Reversible



	D (mm)	T (mm)	H (mm)	L (mm)	(g)	(pce.)
3725Z	28	24.5	13.7	178	236	1

72

3725Z-280 ⚠

Reversible Ratchet
Llave de Carraca Reversible



	D (mm)	T (mm)	H (mm)	L (mm)	(g)	(pce.)
3725Z-280	28	24.5	13.7	280	360	1

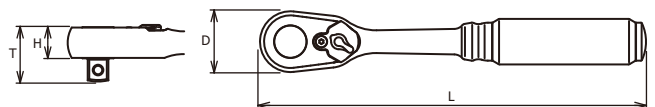

⚠ 3725Z-280 have longer handle than standard, and can be loaded to excessive torque value. In the interest of your own safety always apply load evenly and progressively to avoid breakage and possible injury.

🔪 : Ratchet handles have been modified from 36 tooth to 72 tooth.

Reversible Ratchet with Quick Release Button
Llave de Carraca Reversible con botón de extracción rápida **2725ZB-3/8**

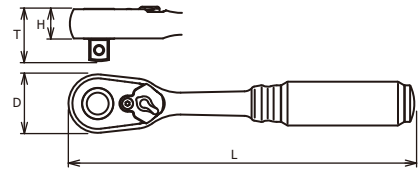

	D (mm)	T (mm)	H (mm)	L (mm)	(g)	(pce.)
New 2725ZB-3/8	20.5	20.5	9.5	114	83	1



Reversible Ratchet Long with Quick Release Button
Llave de Carraca Reversible Larga con botón de extracción rápida **2725ZB-3/8(L160)** ⚠

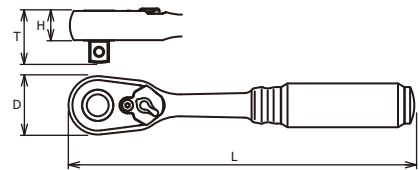

	D (mm)	T (mm)	H (mm)	L (mm)	(g)	(pce.)
New 2725ZB-3/8(L160)	20.5	20.5	9.5	160	120	1



⚠ 2725ZB-3/8(L160) have longer handle than standard, and can be loaded to excessive torque value. In the interest of your own safety always apply load evenly and progressively to avoid breakage and possible injury.

Reversible Ratchet Short with Quick Release Button
Llave de Carraca Reversible Corta con botón de extracción rápida **3725ZSB**

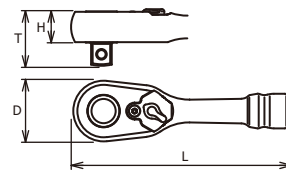

	D (mm)	T (mm)	H (mm)	L (mm)	(g)	(pce.)
New 3725ZSB	28	24.5	13.7	100	157	1



Reversible Ratchet with Quick Release Button
Llave de Carraca Reversible con botón de extracción rápida **3725ZB**

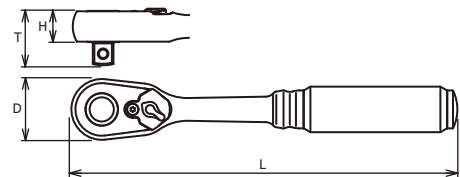

	D (mm)	T (mm)	H (mm)	L (mm)	(g)	(pce.)
New 3725ZB	28	24.5	13.7	178	236	1



Reversible Ratchet Long with Quick Release Button
Llave de Carraca Reversible Larga con botón de extracción rápida **3725ZB-280** ⚠

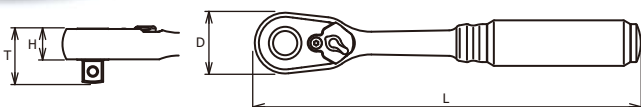

	D (mm)	T (mm)	H (mm)	L (mm)	(g)	(pce.)
New 3725ZB-280	28	24.5	13.7	280	360	1

⚠ 3725ZB-280 have longer handle than standard, and can be loaded to excessive torque value. In the interest of your own safety always apply load evenly and progressively to avoid breakage and possible injury.





2726Z-3/8

Flexible Ratchet, Reversible (Short)
Llave de Carraca Flexible, Reversible (Corta)

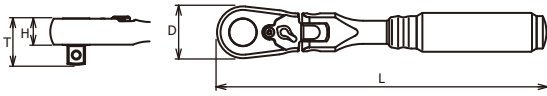

	D (mm)	T (mm)	H (mm)	L (mm)	(g)	(pce.)
2726Z-3/8	20.5	20.5	9.5	114	107	1



2726Z-3/8(L160) ⚠

Flexible Ratchet, Reversible
Llave de Carraca Flexible, Reversible

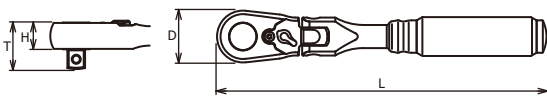

	D (mm)	T (mm)	H (mm)	L (mm)	(g)	(pce.)
2726Z-3/8(L160)	20.5	20.5	9.5	160	130	1

⚠ 2726Z-3/8(L160) have longer handle than standard, and can be loaded to excessive torque value. In the interest of your own safety always apply load evenly and progressively to avoid breakage and possible injury.



3726ZS

Flexible Ratchet, Reversible (Short)
Llave de Carraca Flexible, Reversible (Corta)

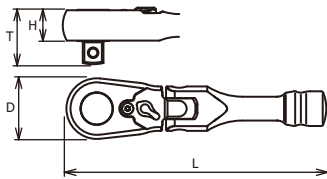

	D (mm)	T (mm)	H (mm)	L (mm)	(g)	(pce.)
3726ZS	28	24.5	13.7	120	196	1



3726Z

Flexible Ratchet, Reversible
Llave de Carraca Flexible, Reversible

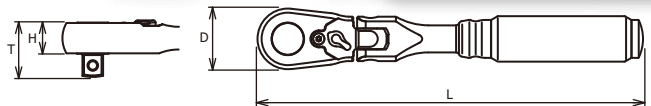

	D (mm)	T (mm)	H (mm)	L (mm)	(g)	(pce.)
3726Z	28	24.5	13.7	178	317	1



3726Z-280 ⚠

Flexible Ratchet, Reversible
Llave de Carraca Flexible, Reversible

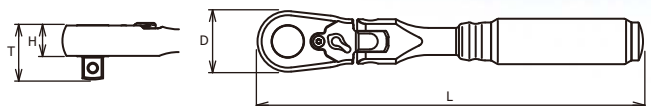

	D (mm)	T (mm)	H (mm)	L (mm)	(g)	(pce.)
3726Z-280	28	24.5	13.7	280	420	1

⚠ 3726Z-280 have longer handle than standard, and can be loaded to excessive torque value. In the interest of your own safety always apply load evenly and progressively to avoid breakage and possible injury.

🔪 : Ratchet handles have been modified from 36 tooth to 72 tooth.

Flexible Ratchet, Reversible with Quick Release Button (Short)
Llave de Carraca Flexible, Reversible con botón de extracción rápida (Corta) **2726ZB-3/8**

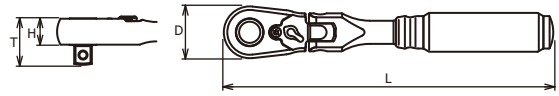

	D (mm)	T (mm)	H (mm)	L (mm)	(g)	(pce.)
New 2726ZB-3/8	20.5	20.5	9.5	114	107	1

Flexible Ratchet, Reversible with Quick Release Button **2726ZB-3/8(L160)** ⚠

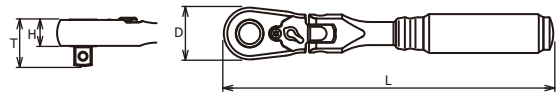

	D (mm)	T (mm)	H (mm)	L (mm)	(g)	(pce.)
New 2726ZB-3/8(L160)	20.5	20.5	9.5	160	130	1

⚠ 2726ZB-3/8(L160) have longer handle than standard, and can be loaded to excessive torque value. In the interest of your own safety always apply load evenly and progressively to avoid breakage and possible injury.

Flexible Ratchet, Reversible with Quick Release Button (Short) **3726ZSB**

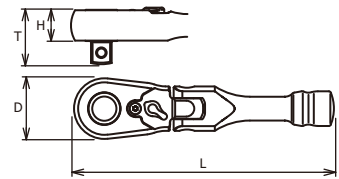

	D (mm)	T (mm)	H (mm)	L (mm)	(g)	(pce.)
New 3726ZSB	28	24.5	13.7	120	196	1

Flexible Ratchet, Reversible with Quick Release Button **3726ZB**

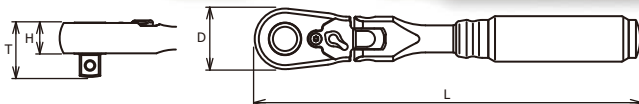

	D (mm)	T (mm)	H (mm)	L (mm)	(g)	(pce.)
New 3726ZB	28	24.5	13.7	178	317	1

Flexible Ratchet, Reversible with Quick Release Button **3726ZB-280** ⚠



	D (mm)	T (mm)	H (mm)	L (mm)	(g)	(pce.)
New 3726ZB-280	28	24.5	13.7	280	420	1

⚠ 3726ZB-280 have longer handle than standard, and can be loaded to excessive torque value. In the interest of your own safety always apply load evenly and progressively to avoid breakage and possible injury.



Oval Shape Shank



Hinge Handle



3768Z-250
3768Z-400 ⚠

Hinge Handle
Mango Articulado



	D (mm)	L (mm)	(g)	(pcs.)
3768Z-250	20.5	250	309	5
3768Z-400	20.5	400	500	2

⚠ 3768Z-400 have longer handle than standard, and can be loaded to excessive torque value. In the interest of your own safety always apply load evenly and progressively to avoid breakage and possible injury.

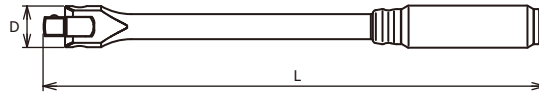

3760Z

Extension Bars
Alargaderas

3760Z	D (mm)	L (mm)	(g)	(pcs.)
75	17.5	75	66	10
125	17.5	125	103	10
250	17.5	250	195	5

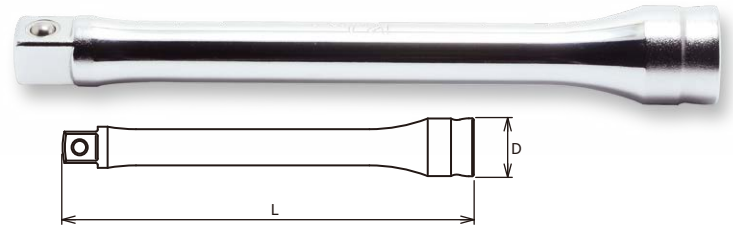

3760LZ ⚠

Locking Extension Bars
Alargadera con Bloqueo

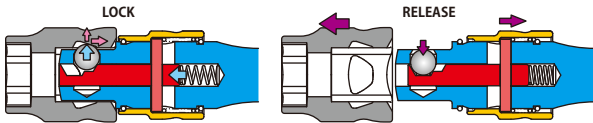

3760LZ	D ₁ (mm)	D ₂ (mm)	L (mm)	(g)	(pcs.)
New 75	17.5	16.5	75	75	10
New 125	17.5	16.5	125	105	10
New 250	17.5	16.5	250	185	5

⚠ You may not hold the sliding part while moving to avoid heating up by friction and reduction by wear.

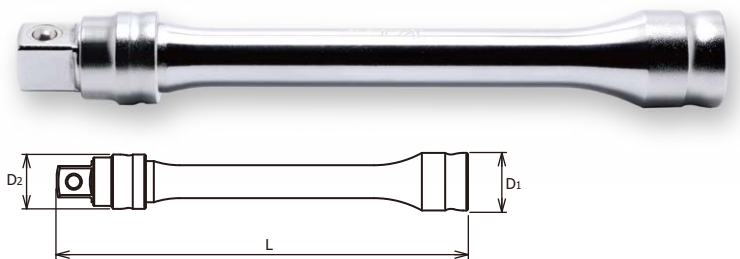

3771Z

Universal Joint
Articulación Universal



Universal Joint

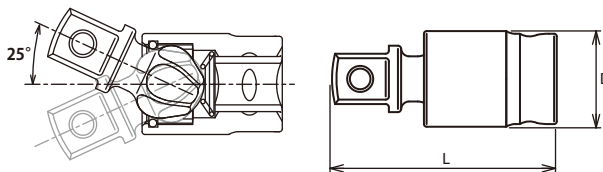

3771Z	D (mm)	L (mm)	(g)	(pcs.)
3771Z	18	42.5	44	10



3772Z

Universal Joint
Articulación Universal

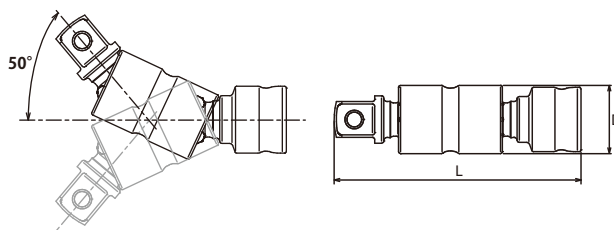

3772Z	D (mm)	L (mm)	(g)	(pcs.)
3772Z	18	65	76	10



Quick Spinner
Disco de Giro Rápido

3756Z

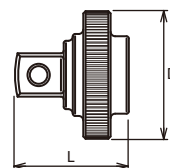

	D (mm)	L (mm)	(g)	(pcs.)
3756Z	28	25	40	10

Quick Spinner
Disco de Giro Rápido

3756ZS

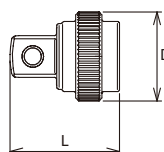

2726Z-3/8 + 3756ZS + Socket

	D (mm)	L (mm)	(g)	(pcs.)
3756ZS	20.3	25	26	10

Quick Spinner
Disco de Giro Rápido

3756Z-1/2

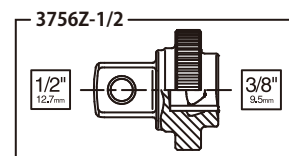
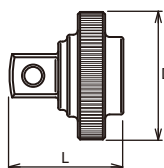

	D (mm)	L (mm)	(g)	(pcs.)
3756Z-1/2	28	29	52	10

Extension Adaptor
Adaptador Alargadera

3322AZ-75

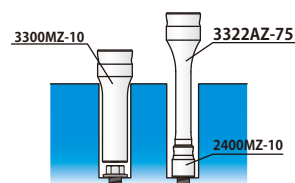
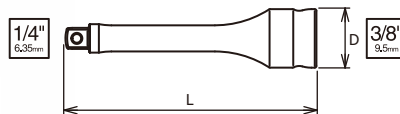

	D (mm)	L (mm)	(g)	(pcs.)
3322AZ-75	17.5	75	42	10





3285Z		26 Pieces Set / 2,100 g	
PLASTIC TRAY : W390xH180xT25			
Sockets		Accessories	
3400MZ 6-pt. Sockets 5.5, 6, 7, 8, 10, 12, 13, 14, 17, 19, 21, 22		3725 Z	
3300MZ 6-pt. Deep Sockets 8, 10, 12, 14		3756 Z	
3300CZ Spark Plug Sockets 14, 16, 20.8		3771Z	
		3768Z-250	
		3760Z-75	
		3760Z-125	
		3760Z-250	

3285Z

Socket Set
Juego de Vasos



3285ZA		15 Pieces Set / 750 g	
PLASTIC TRAY : W300xH90xT25			
Sockets		Accessories	
3400MZ 6-pt. Sockets 5.5, 6, 7, 8, 10, 12, 13, 14, 17, 19, 21, 22		3725 Z	
		3756 Z	
		3771Z	

3285ZA

Socket Set
Juego de Vasos



3286Z		21 Pieces Set / 2,600 g	
BLACK METAL CASE : W415xH120xT50			
Sockets		Accessories	
3400MZ 6-pt. Sockets 7, 8, 10, 11, 12, 13, 14, 15, 16, 17, 18, 19, 21, 22		3725 Z	
		3756 Z	
		3771Z	
		3768Z-250	
		3760Z-75	
		3760Z-125	
		3760Z-250	

3286Z

Socket Set
Juego de Vasos



3285ZE		9 Pieces Set / 600g	
Rail 200mm / PLASTIC BAG			
Sockets		Accessories	
3400MZ 6-pt. Sockets 8, 10, 12, 13, 14, 17, 19		3725 Z	
		3756 Z	

3285ZE

Socket Set
Juego de Vasos



4400MZ 6-point Sockets Vasos Hexagonales

4400MZ (mm)	D ₁ (mm)	D ₂ (mm)	H (mm)	L (mm)	(g)	(pcs.)
8	12.9	20.6	4.5	26	30	10
10	15	20.6	4.5	26	31	10
12	17	20.6	5.5	27	32	10
13	18.3	21.5	6.5	28	40	10
14	19.5	21.5	6.5	28	40	10
16	22	21.5	7.5	29	43	10
17	23	22.5	7.5	29	49	10
18	24.1	23.7	7.5	29	56	10
19	25.3	24.4	9.5	29	62	10
21	27.6	26.3	10.5	29	76	10
22	28.8	27.5	11	29	83	10
24	31.1	29.2	12	29	96	5
27	34.6	32.2	13.5	30	124	5
30	38.1	35.2	14.5	31	156	5
32	40.4	36.8	15.5	32	178	5

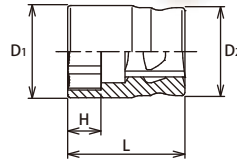

RS4400MZ/10 Socket Set on Rail Juego de Vasos en Regleta

RS4400MZ/10	10 Pieces Set / Rail 300mm	(g)
10, 12, 13, 14, 17, 19, 21, 22, 24, 27		830



4725Z Reversible Ratchet Llave de Carraca Reversible

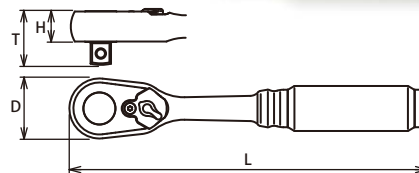

4725Z	D (mm)	T (mm)	H (mm)	L (mm)	(g)	(pce.)
4725Z	36.5	32.8	18.2	253	595	1



4725ZB Reversible Ratchet with Quick Release Button Llave de Carraca Reversible con botón de extracción rápida

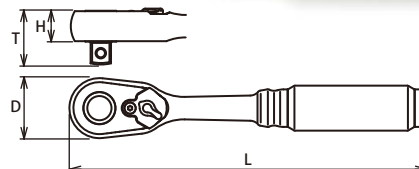

4725ZB	D (mm)	T (mm)	H (mm)	L (mm)	(g)	(pce.)
4725ZB	36.5	32.8	18.2	253	595	1

 : Ratchet handles have been modified from 36 tooth to 72 tooth.

4300PMZ-65 ⚠️

Wheel Nut Sockets
Vasos para Ruedas

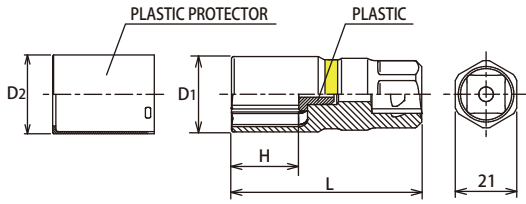

	4300PMZ.65 (mm)	D1 (mm)	D2 (mm)	H (mm)	L (mm)	Colour	(g)	(pcs.)
New	17	23.7	25.2	21	65	Blue	135	10
New	19	25.7	27.2	23	65	Red	150	10
New	21	27.5	29	25	65	Yellow	155	10
New	22	29	30.5	26	65	White	165	10



⚠️ Please note that thin walled design is only for wheel nut work and Torque rating is limited.



FREE-TURN
CROSS WRENCH



4711XZ

Spinning Cross Wrench
Llave en Cruz Deslizante para Montaje de Ruedas

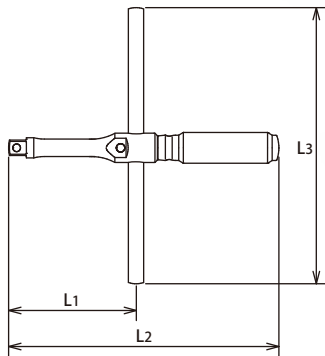

	L1 (mm)	L2 (mm)	L3 (mm)	(g)	(pce.)	
New	4711XZ	133	264	350	915	1



Hinge Handle



Oval Shape Shank



4768Z-430 ⚠️

Hinge Handle
Mango Articulado



	D (mm)	L (mm)	(g)	(pcs.)
4768Z-430	28	430	720	2

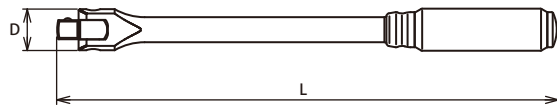

⚠️ 4768Z-430 have longer handle than standard, and can be loaded to excessive torque value. In the interest of your own safety always apply load evenly and progressively to avoid breakage and possible injury.

Extension Bars
Alargaderas

4760Z

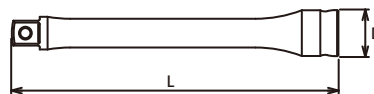

4760Z	D (mm)	L (mm)	(g)	(pcs.)
125	23	125	180	5
250	23	250	340	5

Locking Extension Bars
Alargadera con Bloqueo

4760LZ

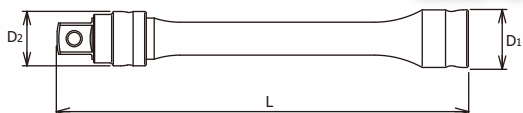
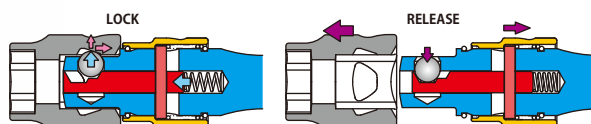

4760LZ	D1 (mm)	D2 (mm)	L (mm)	(g)	(pcs.)
125	23	20.5	125	186	5
250	23	20.5	250	346	5

 You may not hold the sliding part while moving to avoid heating up by friction and reduction by wear.

Universal Joint
Articulación Universal

4771Z

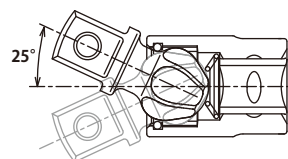
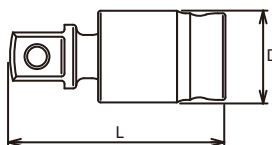

Universal Joint

4771Z	D (mm)	L (mm)	(g)	(pcs.)
4771Z	23.7	55.8	100	10

Universal Joint
Articulación Universal

4772Z

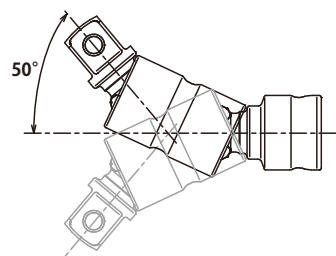
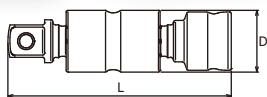

4772Z	D (mm)	L (mm)	(g)	(pcs.)
4772Z	23.7	87.2	170	5

Quick Spinner
Disco de Giro Rápido

4756Z

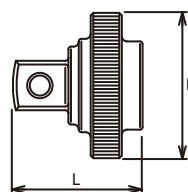

4756Z	D (mm)	L (mm)	(g)	(pcs.)
4756Z	36.3	33.5	84	10

4285Z		21 Pieces Set / 4,800 g	
BLACK METAL CASE : W445xH190xT50			
Sockets		Accessories	
	4400MZ 6-pt. Sockets		4725 Z
	8, 10, 12, 13, 14, 16, 17, 18, 19, 21, 22, 24, 27, 30, 32		4756 Z
			4771Z
			4768Z-430
			4760Z-125
			4760Z-250

4285Z Socket Set
Juego de Vasos



4285ZE		11 Pieces Set / 1,380g	
Rail 300mm/PLASTIC BAG			
Sockets		Accessories	
	4400MZ 6-pt. Sockets		4725 Z
	10, 12, 13, 14, 17, 19, 21, 22, 24		4756 Z

4285ZE Socket Set
Juego de Vasos



RSAL200 Rail
RSAL300 Regleta



RSAL200		RAIL (mm)	CLIP (pcs.)	(g)	(pce.)
1/4 x 12	1/4"	200	12	125	1
3/8 x 8	3/8"	200	8	130	1
RSAL300		RAIL (mm)	CLIP (pcs.)	(g)	(pce.)
3/8 x 12	3/8"	300	12	180	1
1/2 x 10	1/2"	300	10	190	1

RSAL
CLIP.P/5



RAIL

	RAIL (mm)	(g)	(pce.)
RSAL-200	200	110	1
RSAL-300	300	145	1
RSAL-400	400	210	1

CLIP

CLIP.P/5		(g)	(pce.)
1/4	1/4"	10	5
3/8	3/8"	13	5
1/2	1/2"	20	5

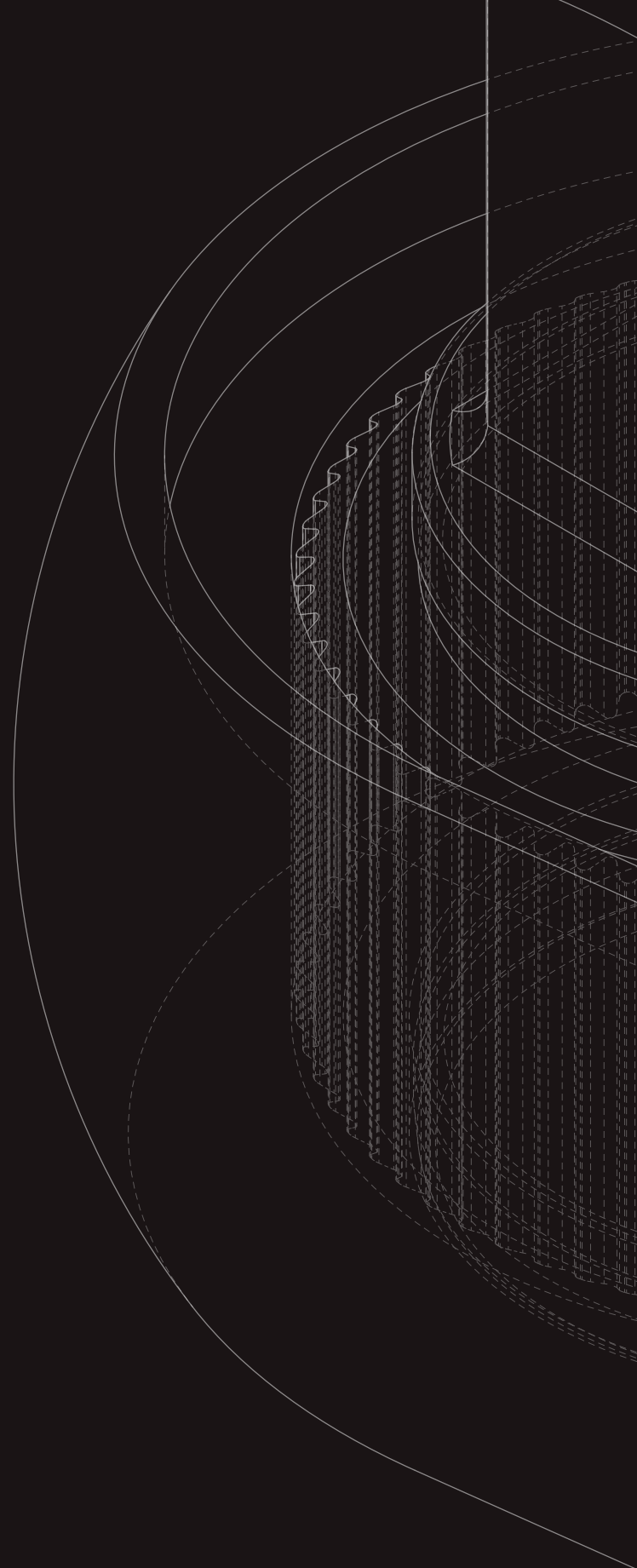

***Koken* TOOL CO., LTD.**

www.koken-tool.co.jp/en/

2023.09